



Welcome RUSSIAN  
PROJECT - XXI VEK

Exploded View:

1 2 3 4 5

Search

PJET20279

Go

English

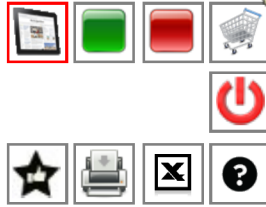

MENU

SPARE PART LIST





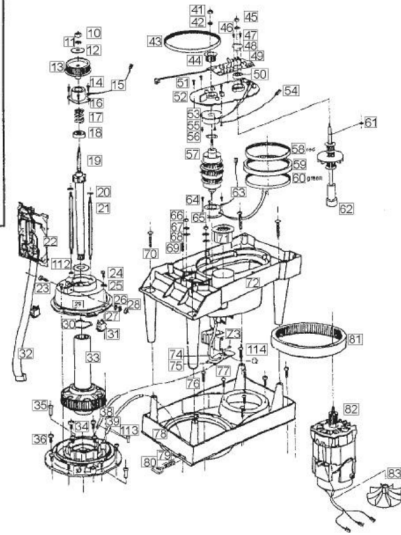
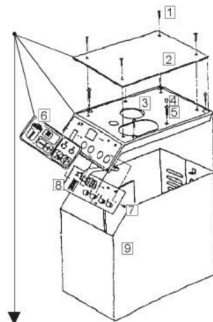
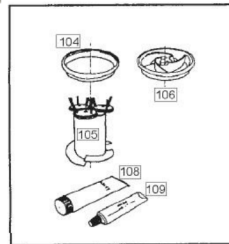



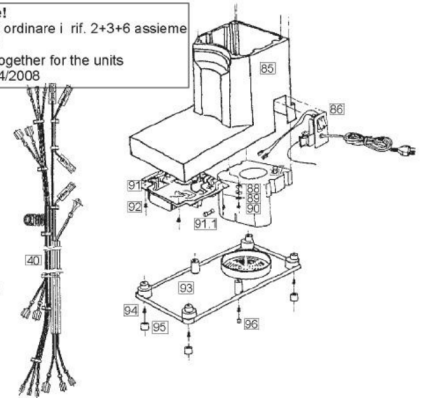
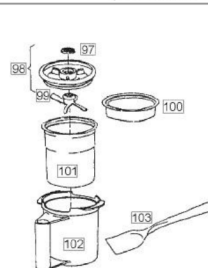



















PACOJET matr. Until 50 08 09 30052

REF	ART	COD	€ (Net)
	01	SCREW	PJET51033 0,60
	02	S/S COVER FROM 05/2008 FOR PACOJET	PJET31284 36,17
	03	PLASTIC COVER FOR PACOJET FRM 05/08	PJET31285 50,23
	04	GUARNIZIONE	PJET43709 0,86
	05	SCREW	PJET51032 0,60
	06	SERIGRAPH. KEYPAD COVER FOR PACOJET	PJET30514 45,54
	07	SCREW	PJET51031 0,57
	08	KEYPAD	PJET30528 125,91
	09	SHEET CASING ASSY	PJET30610 323,71
	10	NUT	PJET52001 0,28
	11	WASHER	PJET50004 0,28
	12	WASHER	PJET80072 0,24
	13	PULLEY	PJET30505 24,11
	14	SCREW	PJET51023 0,57
	15	POWER CORD	PJET42278 4,02
	16	SPRING COVER	PJET42208 9,38
	17	SPRING	PJET42211 3,75
	18	BALL BEARING _ PACOJET	PJET43836 9,38
	19	COMPLETE SHAFT FOR PACOJET	PJET30517 134,62































**Attenzione!**  
Per le macchine prodotte fino a 04/2008 ordinare i rif. 2+3+6 assieme  
**Warning!**  
Ref. 2+3+6 must be ordered together for the units produced until 04/2008



	20	WASHER	PJET80071	0,28
	21	DISTANCE PIECE	PJET42265	10,72
	22	ELECTRONIC POWER BOARD	PJET30530	271,25
	23	HEXAGONAL SCREW	PJET51036	0,57
	24	HEXAGONAL SCREW	PJET51034	0,28
	25	WASHER	PJET50005	0,28
	26	WASHER	PJET80079	0,28
	27	WASHER	PJET50003	0,28
	28	NUT	PJET52002	0,57
	29	BALL BEARINGS' COVER	PJET20283	43,32
	30	WASHER	PJET80011	3,22
	31+35	MICROSWITCH KIT	PJET43919	13,11
	32	RIBBON WIRE PJET	PJET42285	21,43
	33	TRASCINATORE	PJET42214	184,85
	34	HEXAGONAL SCREW	PJET51035	0,57
	37	BALL BEARING HOLDER	PJET42197	128,25
	38	TUBETTO SILICONICO	PJET42246	2,14
	39	TUBETTO SILICONICO	PJET42328	5,36
	40	ELECTRICAL SYSTEM	PJET30534	61,73
	42	WASHER	PJET50003	0,28
	43	"YELLOW" BELT	PJET80106	9,38
	44	PULEGGIA DENTATA Z=26	PJET30508	8,04
	45	DADO	PJET52003	0,57
	46	WASHER	PJET50005	0,28
	47	VITE	PJET51025	0,57
	48	MISURATORE VELOCITÀ	PJET42236	13,68
	49	SCHEDA MIS. VELOCITÀ	PJET30518	66,97
	50	CUSCINETTO	PJET80005	9,38
	51	VITE	PJET51025	0,57

	52	COPERTURA	PJET20286	34,83
	53	MAGNETE	PJET42266	85,73
	55	VITE	PJET51022	0,57
	56	RONDELLA ONDULATA	PJET80010	6,56
	57	RIDUTTORE (1-10)	PJET30507	271,25
	58	TOOTHED BELT RED _ PACOJET	PJET80105	9,38
	59	TOOTHED BELT WHITE _ PACOJET	 PJET80104	8,04
	60	TOOTHED BELT GREEN _ PACOJET	PJET80103	9,38
	61	WASHER	PJET80017	0,28
	62	GEAR KPL	PJET42240	141,99
	64	VITE	PJET51022	0,57
	65	MAGNETE	PJET42202	85,50
	66	DADO	PJET52003	0,57
	67	WASHER	PJET50005	0,28
	68	WASHER	PJET80071	0,28
	69	MOLLA	PJET42274	1,71
	70	VITE A.F.	PJET51030	0,86
	71	FILTRO ARIA	PJET42241	13,40
	72	TOP FRAME	PJET10147	53,68
	73	POMPA ARIA	PJET44684	136,63
	74	TUBO ARIA SILICONE	PJET42247	3,70
	75	BLOCCAGGIO POMPA	PJET42333	5,13
	76	VITE	PJET51029	0,57
	77	VITE	PJET51028	0,86
	78	CHASSIS INFERIORE	PJET10146	56,26
	79	COMPRESSION SPRING	PJET41639	0,86
	80	VALVOLA ARIA	PJET42270	4,02
	81	BELT PACOJET	PJET80102	18,75
	82	MOTORE 220/50 UNTIL MAT.50080930052	PJET42239	204,94
	83	VENTOLA RAFF.	PJET30550	7,03

	85	BASE	PJET42185	190,88
	87	VENTILATION FUNNEL	PJET30830	29,47
	88	RONDELLA ELASTICA	PJET42340	1,71
	89	WASHER	PJET50005	0,28
	90	VITE A.F.	PJET51027	1,71
	91.1	FUSIBILE	PJET80140	6,84
	91	SCHEDA ALIM. MAT. UNTIL 50080930052	PJET30529	271,25
	92	VITE A.F.	PJET51024	0,28
	93	COPERTURA INF.	PJET10145	38,19
	94	VITE A.F.	PJET51024	0,28
	95	PIEDINO	PJET42219	2,28
	96	GUARANTEE-SEAL	PJET43710	0,86
	97	SEAL GASKET	PJET42272	15,96
	98	SPLASH-GUARD ASSY. (BLACK RUBBER)	PJET42273	44,20
	99	STANDARD KNIFE FOR PACOJET 	69012006	140,12
	100	PLASTIC LID	PJET30531	6,03
	101	BEAKER FOR PACOJET WITH LID	69012002	45,60
	102	OUTER/PROTECTIVE BEAKER FOR PACOJET	PJET20279	42,19
	103	SPATULA	PJET42309	37,51
	104	SEAL RING BLU	PJET42300	20,09
	105	CLEANING INSERT/BRUSHES	PJET42296	64,30
	106	RINSING RING	PJET30538	56,26
	108	GRASSO	PJET80027	32,15
	109	EATABLE FATS	PJET80033	69,65
	112	WASHER	PJET42360	1,21
	113	BUSSOLA TUBO ARIA	PJET42472	3,48
	114	SPRING	PJET80013	1,71